

Silicon NPN Power Transistors

2SC2590

DESCRIPTION

- With TO-126 package
- Complement to type 2SA1110
- Excellent current I_C characteristics of forward current transfer ratio h_{FE} vs. collector
- High transition frequency f_T
- Optimum for the driver stage of a 40 W to 60 W output amplifier

APPLICATIONS

- For low-frequency power amplification

PINNING

PIN	DESCRIPTION
1	Emitter
2	Collector;connected to mounting base
3	Base

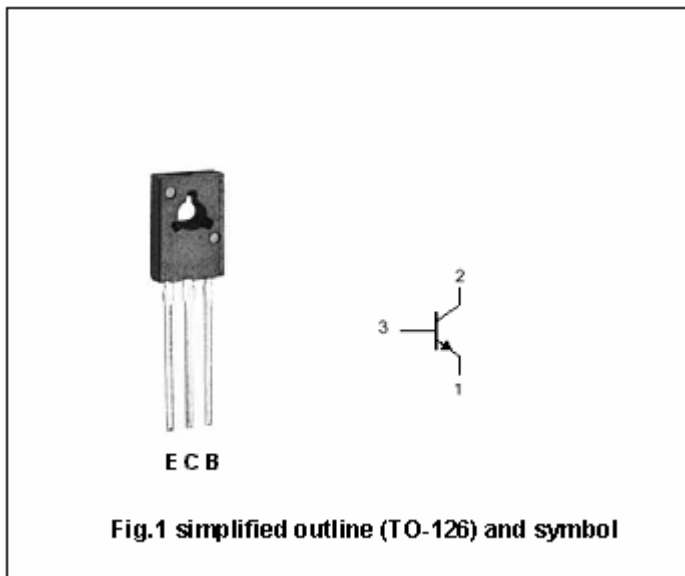

Absolute Maximun Ratings (Ta=25)

SYMBOL	PARAMETER	CONDITIONS	VALUE	UNIT
V_{CBO}	Collector-base voltage	Open emitter	120	V
V_{CEO}	Collector-emitter voltage	Open base	120	V
V_{EBO}	Emitter-base voltage	Open collector	5	V
I_C	Collector current (DC)		0.5	A
I_{CM}	Collector current-Peak		1.0	A
P_C	Collector power dissipation	$T_C=25$	1.2*	W
T_j	Junction temperature		150	
T_{stg}	Storage temperature		-55~150	

Note) *: Without heat sink

Silicon NPN Power Transistors

2SC2590

CHARACTERISTICS

T_j=25 unless otherwise specified

SYMBOL	PARAMETER	CONDITIONS	MIN	TYP.	MAX	UNIT
V _{(BR)CEO}	Collector-emitter breakdown voltage	I _C =100 μ A; I _B =0	120			V
V _{(BR)EBO}	Emitter-base breakdown voltage	I _E =10 μ A; I _C =0	5			V
V _{CEsat}	Collector-emitter saturation voltage	I _C =0.3A; I _B =30mA			1.0	V
V _{BEsat}	Base-emitter saturation voltage	I _C =0.3A; I _B =30mA			1.2	V
h _{FE-1}	DC current gain	I _C =150mA; V _{CE} =10V	90		220	
h _{FE-2}	DC current gain	I _C =0.5A; V _{CE} =5V	65	100		
C _{OB}	Output capacitance	I _E =0; V _{CB} =10V; f=1MHz			20	pF
f _T	Transition frequency	I _C =50mA; V _{CB} =10V, f=200MHz		200		MHz

◆ h_{FE-1} Classifications

Q	R
90-155	130-220

Silicon NPN Power Transistors

2SC2590

PACKAGE OUTLINE

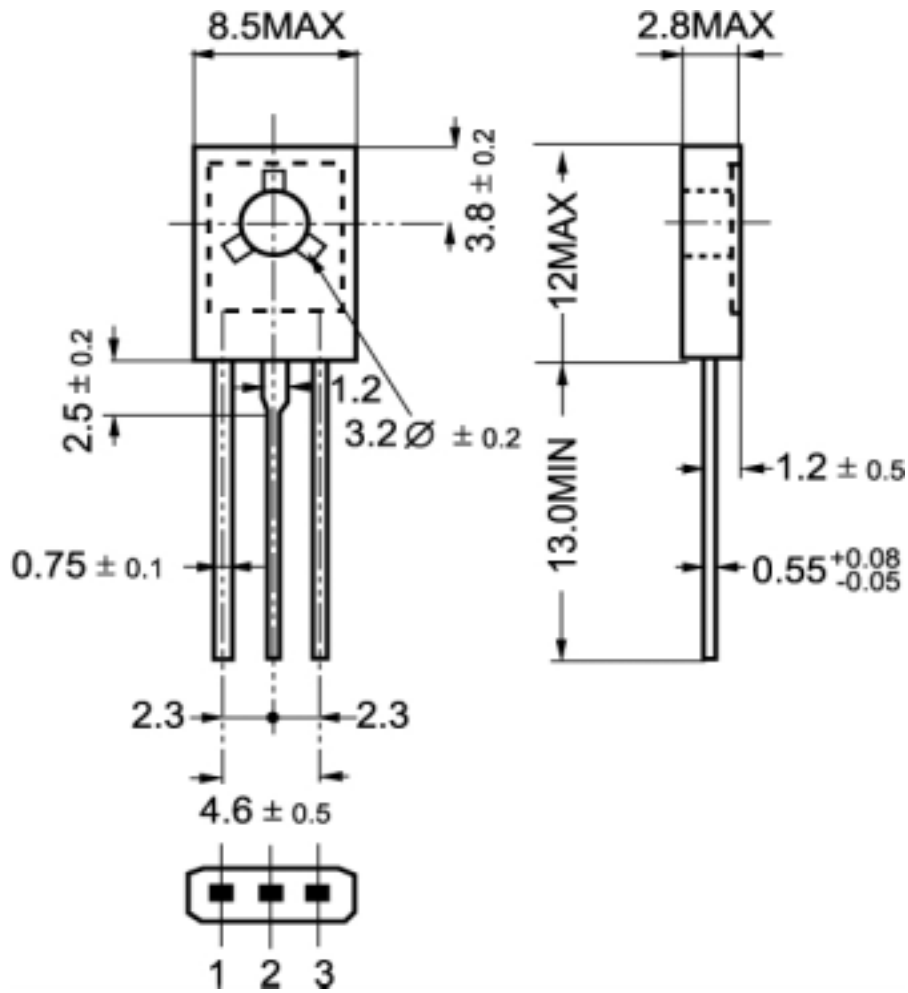

Fig.2 Outline dimensions

Silicon NPN Power Transistors

2SC2590

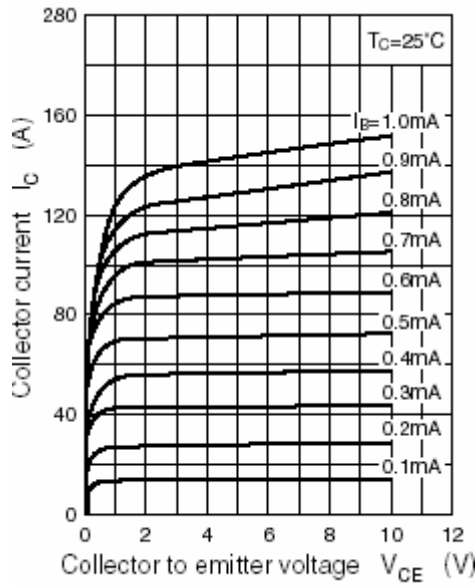

Fig.3 Static Characteristic

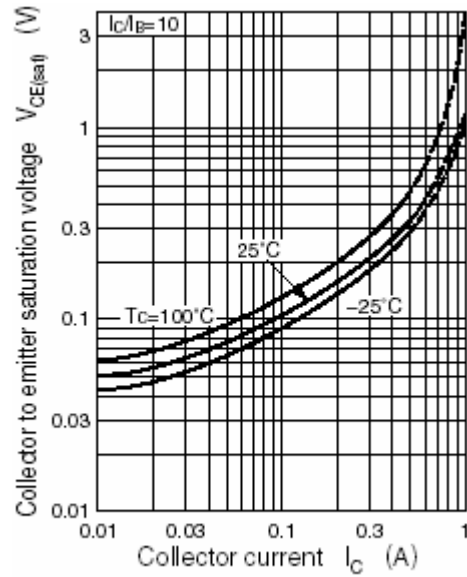

Fig.4 Collector-Emitter Saturation Voltage

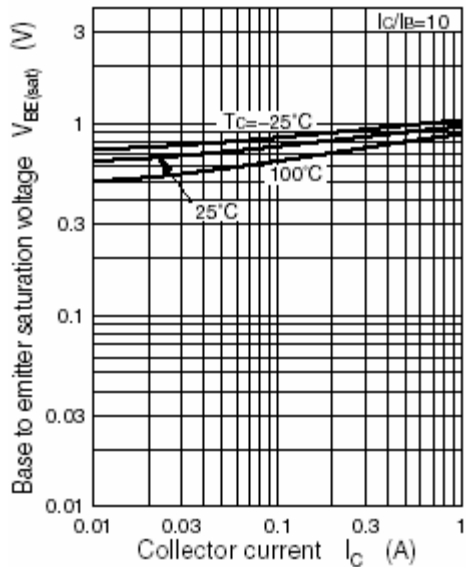

Fig.5 Base-Emitter Saturation Voltage

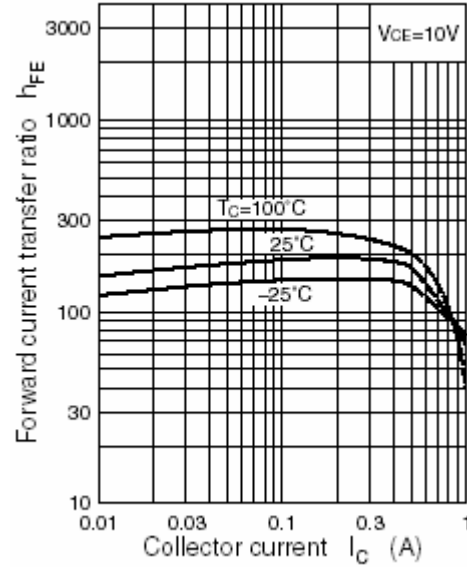

Fig.6 DC current Gain

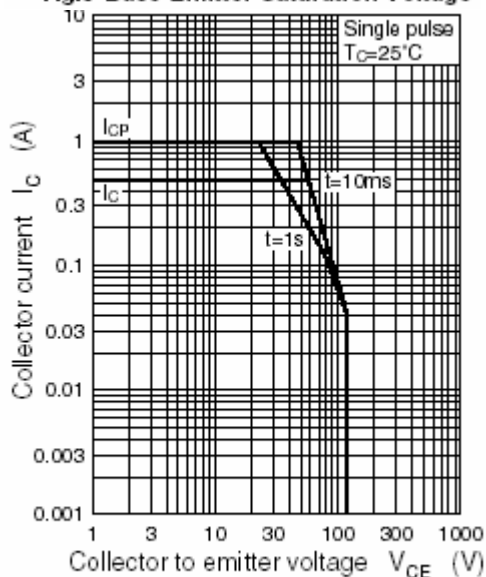

Fig.7 Safe Operating Area